



FA 60 041 00





P. 1 | 2

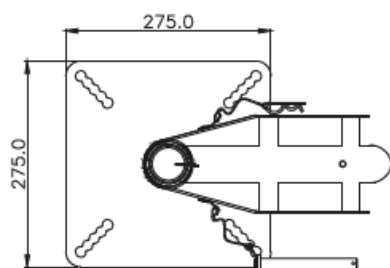
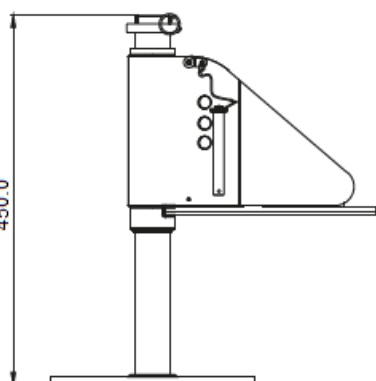
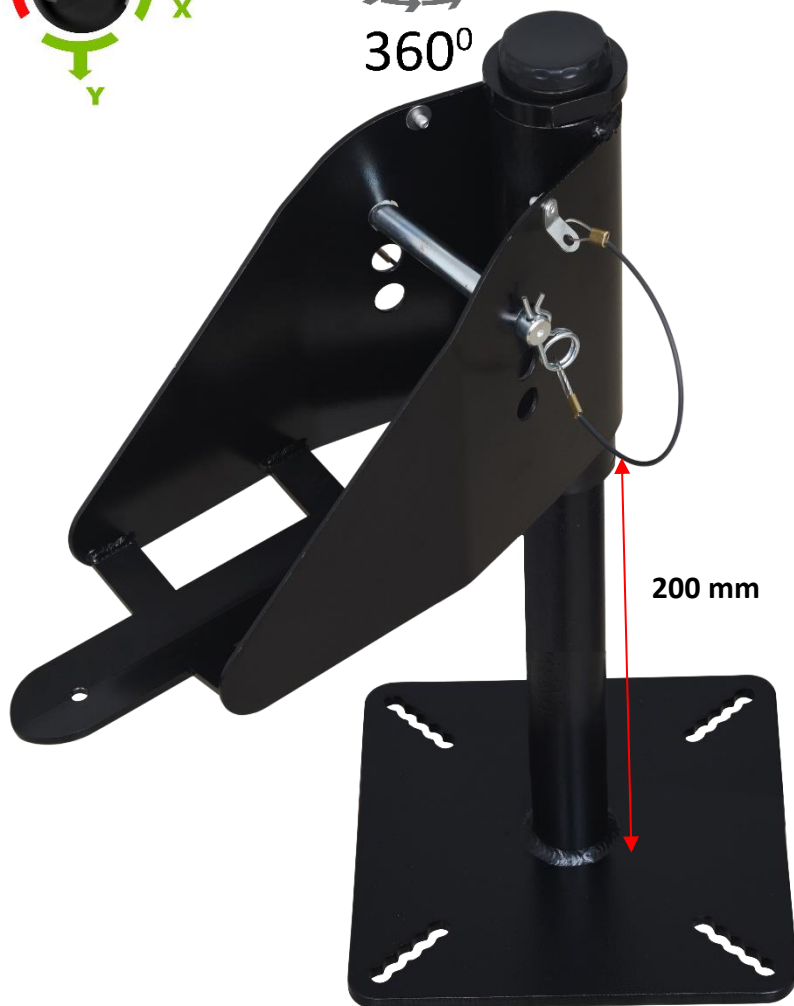

360°

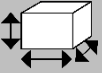

HS CODE
73269098
CARTON SIZE / PCS.
50x30x51 cm / 1
Certificate of Conformity n°RQC2023-096/A-1
QUINTIN CERTIFICATIONS
825 route de Romans
38160 SAINT ANTOINE L'ABBAYE (France)

REF.	FA 60 041 00
CE	EN 795:2012 Type A
	x1
MAT.	
DIM.	450 mm x 275 mm x 275 mm
R (kN) / MBS (kN)	12 kN / 15 kN
	4x M12
+	Compatible with all KRATOS SAFETY blocks from 6 m to 30 m, except KRONOS & TRITON blocks
	12.00 KG



Nombre d'utilisateurs
Number of users
Cantidad de usuarios
Quantità di utilizzatori
Anzahl der Benutzer

R (kN) / MBS (kN)

Résistance statique (en kN) / Résistance à la rupture
Static strength / Minimum Breaking Strength
Resistencia estática (en kN) / Resistencia a la ruptura (en kN)
Resistenza statica (in kN) / Resistenza alla rottura (in kN)
Statische Festigkeit (in kN) / Bruchfestigkeit (in kN)

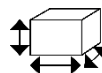

Fixations à utiliser / Dimensions de la structure d'accueil
Fasteners to use / Dimensions of the receiving structure
Fijaciones que deben usarse / Dimensiones de la estructura receptora
Elementi di fissaggio da utilizzare / Dimensioni della struttura ospitante
Zu verwendende Befestigungen / Abmessungen der Aufnahmestruktur